

# Solar Inverter

user manual

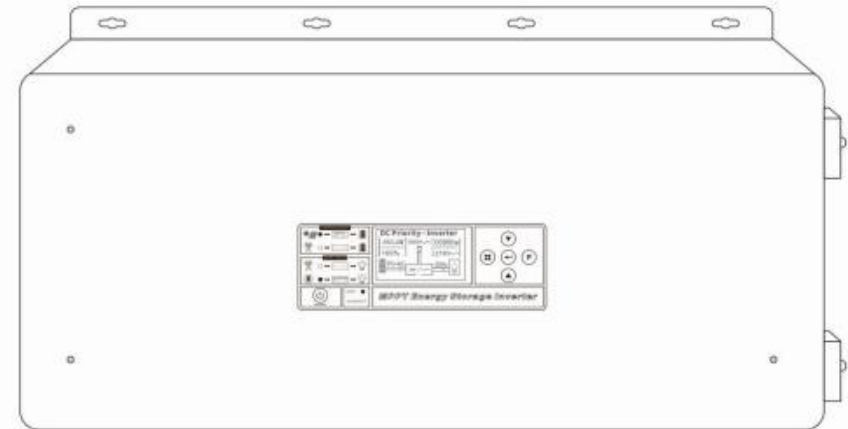

*Open green life*  
*Build bright future*

Guangzhou Sunnysky Solar Equipment Co.,Ltd

Address:No.6 Building 6, Yiheng Road, Xipengling, Hebian Wushe Industry Area,Baiyun District,Guangzhou,China

Tel:0086-20-86298343

Web: www. didisolar. com

Email:sales@didisolar.com

TYI series

Model:0.5kw-6KW

## Content

1 Safety instructions .....	2-3
2 Sketch of product appearance .....	4
3 LCD display description .....	5
4 Technical data .....	6-7
5 product description .....	8-9
6 Work mode instructions .....	10
7 Installation steps .....	11
8 Trouble shooting and solutions .....	12
9 Quality guarantee .....	13

# 1 Safety instructions

## 1.1 Safety responsibility immunities





Users should read this chapter carefully and operate according to safety cautions required by this chapter when installing, use and maintain this product. If there appears damage or loss caused by violation operations, it has no business with our company.

## 1.2 Safety sign illustration

 Note: due to dangers caused by violation operations, it might result in moderate damage or light injury to person as well as damage to products.



 Danger? Due to dangers caused by violation operations, it might result in fire, persons serious injury even death.

## Safety instructions

Transport	 Danger
	It should avoid strong vibration, fall, collisions and packing box upset down is prohibited during moving. Do not loss accessories, instructions and guarantee card etc. during unpacking and moving.
	 Note
Unpacking and inspecting.	Please pay attention to safety during moving to avoid harming to your body.
	 Note
Installation	<ul style="list-style-type: none"> <li>• If product damage or lack of components, you can not install, or accident maybe happened.</li> <li>• If packing list not agree with the product, please do not install and contact supplier on time.</li> </ul>
	 Danger
	<ul style="list-style-type: none"> <li>• Wiring work must be conducted by qualified electrical engineering personnel, otherwise there is risk of electric shock or damage to the system</li> <li>• Must make sure power supply is off before wiring, or there is risk of electric shock or fire.</li> <li>• AC input has overload and electricity leakage protection.</li> <li>• Cables must meet with related requirements, distribution section must meet with safety regulations.</li> <li>• Installing must be conducted strictly according to installation steps illustrated in the following chapters, otherwise it will cause damage to products.</li> </ul>
	 Note
	<ul style="list-style-type: none"> <li>• When moving and installing, please handling with care to avoid injuring feet or damage to products.</li> <li>• This product should be keep away from inflammable objects and heat source, as well as no shelter to back panel cooling fan.</li> <li>• When installing, do keep sundries from dropping inside the product, otherwise it will cause system failure.</li> <li>• The product must be ground connected reliably, ground wire should be as short as possible, to avoid electric shock.</li> </ul>

# 1 Safety instructions

## Safety instructions

Operating	 Danger
	<ul style="list-style-type: none"> <li>• Before operating, please make sure this product is operated within the allowed working range, otherwise, it will cause damage to this product.</li> <li>• When do not use this product for long time, the battery should be full charged, and battery breaker should be disconnected to avoid battery full discharged caused by long term standing of battery</li> <li>• When do not use this product for long time, it should be charged for more than 2-4 hours by AC or solar energy input after charging the battery breaker should be disconnected.</li> </ul>
	 Danger
Maintenance overhaul	When disassemble the shell, please do disconnect solar energy input, AC input, AC output and battery breaker, otherwise there will be risk of electric shock.
	<p>Even after disassembling the sell, there will remains electricity inside the machine, please do no touch naked part of the wire directly to avoid electric shock.</p> <p>Maintenance and overhaul should be conducted by professional maintenance personnels, uses do not disassemble the machine by themselves, otherwise it will cause electric shock and damage to this product.</p>
Others	 Danger
	Transforming by oneself is prohibited to avoid serious accident.
	<p>When abnormal situation appears inside the machine, please disconnect battery breaker and power source input and output wire immediately.</p> <p>If the machine is on fire by any chance, please use dry powder extinguisher and disconnect all switches immediately.</p> <p>The machine should be started and operated only after the battery is connected, otherwise the machine will be damaged.</p>

## 2 Sketch of product appearance

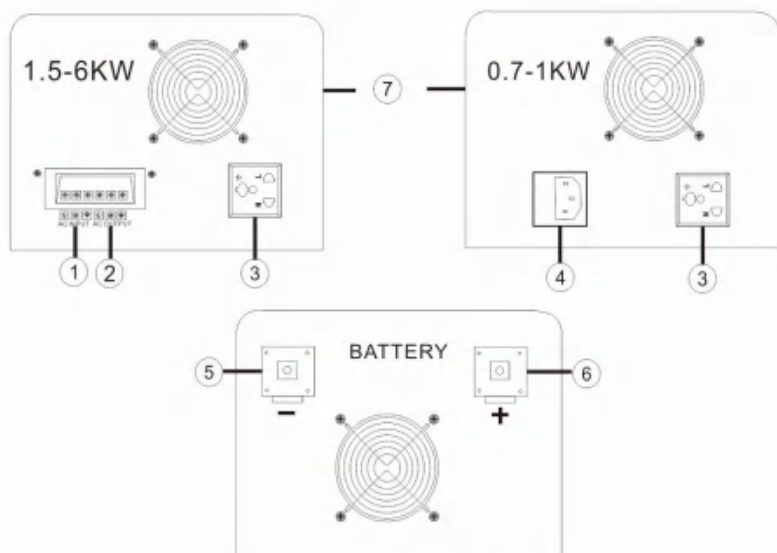

Machine description

1	AC input terminal ( live wire, neutral wire and earth wire)
2	AC output terminal (live wire, neutral wire and earth wire)
3	AC output universal socket( The max. current shall not exceed 10A)
4	AC input socket
5	Battery positive terminal
6	Battery negative terminal
7	Cooling fan

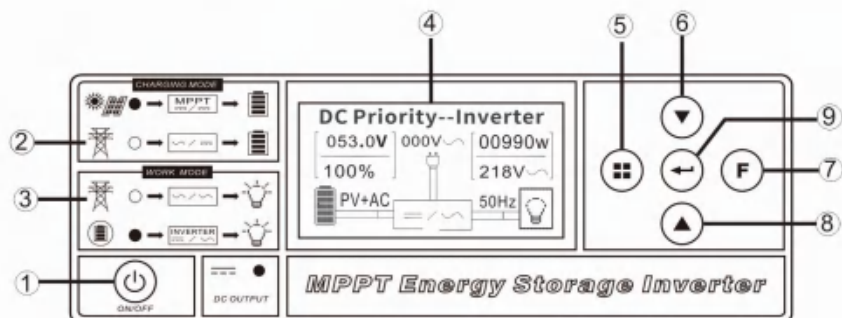

## 2 LCD display description

1	Power start switch
2	AC charging mode- indicator light on
3	AC working mode- indicator light on
4	Display
5	Menu
6	Down
7	Shortcut
8	Up
9	Enter

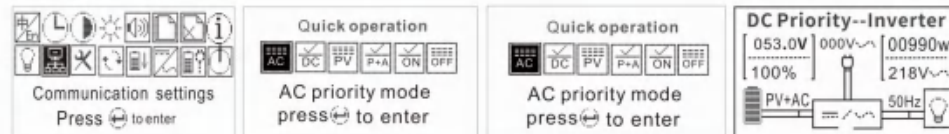

LCD display functional description

	Language settings		Mains charging setting
	Date and time settings		Standby mode
	Contrast settings		Battery type setting
	Brightness setting		Rated voltage setting
	Sound setting		Charging voltage setting
	Record query( Fault record)		Charging current setting
	Clear record		Discharge limit setting
	SYS info query		Restore factory settings
	Communication settings		City power priority mode
	Operating parameter settings		Battery priority mode
	Working mode		Solar+city power charging mode
	Charging mode		Standby mode
	Switching voltage setting		Boot mode



#### 4 Technical data

MODEL(TYI-)		0712	0724	1024	1524	1548	2024	2048	3024	3048	4048	4096	5048	5096	6048	6096
Rated capacity		1000VA		1500VA	2000VA		3000VA		5000VA		6000VA		7000VA		8000VA	
Rated Power load		700W		1000W	1500W		2000W		3000W		4000W		5000W		6000W	
Input	DC input	DC10.5-15V(12V)/DC21-30V(24V)/DC42-60V(48V)/DC84-120V ( 96V)														
	AC input voltage(Vac)	190-275VA														
	Frequency (Hz)	50/60Hz±5% Auto )														
Output	Voltage	220V/230V240V/110V±3%														
	Frequency	50/60Hz±5%														
	Wave form	Pure sine wave														
	Transfer efficiency	≥85% ( full load )														
	Wave form distortion factor	≤3%														
	Output power load factor	≥0.8( > 30% Load )														
Protection	Overload capacity	105-120% 30S;120-150% 10S;>150% 5S														
	Low voltage	DC10.5V(12V)/DC21V(24V)/DC42(48V)/DC84V , Alarm and shut down														
	High temperature	85° Auto shut-down after alarm														
	Short-circuit	Automatic shut-down														
	Over voltage	DC17V(12V)/DC33V(21V)/DC66(48V)/DC128V , Auto shut-down after alarm														
Grid charge	Charge current	0-30A adjust														
Function	Setting	Chiese&English optional、Time&date setting、 Contrast、 Brightness、 Sound、 Voltage switch、 Grid charge、 Clear records、 Reset														
	Work Mode ( Optional )	Grid first/battery first//standby mode														
	LCD display	Record ( Fault Record ) 、 system information														
Others	Switch time	≤4mS														
	Cooling method	fan														
	Noise[dBA]	<60														
	Work Temperature(°C)	-10 ~ 50														
	Environment Humidity	10% ~ 90%(No condensation)														
	Working elevation(M)	<3000 (>1000m,Derating)														

## 5 Product description

### 5.1 Consists of off-grid PV power system

The off-grid PV power system consists of PV modules, controller/ inverter, batteries and AC(power grid).

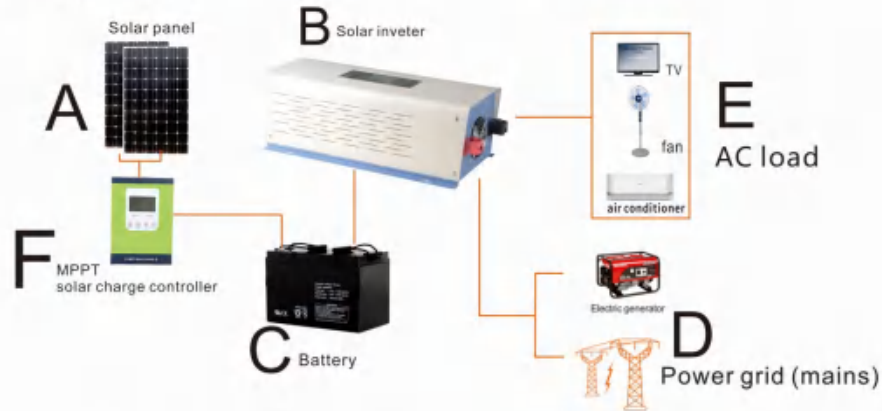

Name	Describe	Note
A	PV module	Monocrystalline, polycrystalline
B	Inverter	Inverter unit
C	Battery	Optional battery type(the default item is lead-acid battery)
D	Commercial power grid (AC)	50Hz/220V, 230V, 240V 60Hz/110V, 120V
E	AC load	Inductiveness, resistiveness, capacitive
F	Solar charge controller	Charging control unit

### 5.2 System block diagram

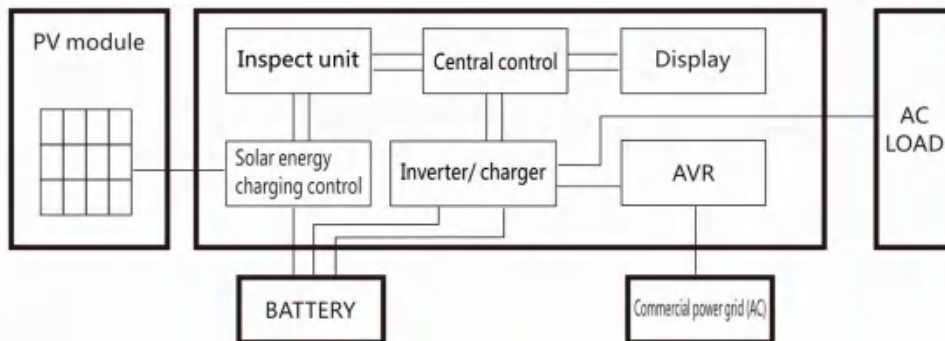

## 5.3 Functional Setting attention

### 1.Factory reset password

When the machine cannot operate normally due to incorrect setting of operating parameters, it can be restored to the factory settings.

**Press DOWN key 3 times and press UP key 3 times, then press ENTER key to enter the operation parameter**

### 2.Power-on test run



Attention: Please check the polarity of positive and negative poles of all DC connection wires before power-on test run.

Follow these steps to test run:

- 1.Check that the positive and negative poles of the connecting wire must be connected correctly.
- 2.First , open the circuit breaker connected to the battery.
- 3.Battery type: factory default lead-acid maintenance-free battery

### 3. Record query



First, under the default main interface, press MENU key to enter the main menu. Second, press DOWN key to select the record query. Third, press ENTER key to enter the record query. Fourth, press DOWN key or UP key to select curve query or fault record query. Fifth, press ENTER key to enter curve record query or fault record query. Sixth, press DOWN or UP key to read records. A total of 10 records. Finally, press MENU to return to previous menu and home page.

### 5.4 Wire and switch configuration table

Wire and circuit breaker specification configuration table																		
Capacity	0.7KW		1.0KW		1.5KW		2.0KW		3.0KW		4.0KW		5.0KW		6.0KW			
DC Voltage(V)	12	24	12	24	24	48	24	48	24	48	48	96	48	96	48	96		
Battery wire mm <sup>2</sup>	10	10	16	10	16	10	16	10	25	16	25	16	25	16	35	16		
Circuit breaker	Battery		60A	32A	60A	32A	60A	60A	125A	60A	125A	60A	125A	60A	125A	60A		
	Capacity		0.7KW		1.0KW		1.5KW		2.0KW		3.0KW		4.0KW		5.0KW		6.0KW	
AC voltage	110	220	110	220	110	220	110	220	110	220	110	220	110	220	110	220		
Neutral wire/Live wire mm <sup>2</sup> (Input/Output)	1.0	1.0	1.0	1.0	2.5	1.5	4	4	6	2.5	6	4	10	6	10	6		
Circuit breaker	AC input		16A	16A	16A	16A	16A	16A	32A	16A	32A	16A	60A	32A	60A	32A	60A	32A
	AC output		16A	16A	16A	16A	16A	16A	32A	16A	32A	16A	60A	32A	60A	32A	60A	32A



## 6 Work mode instructions

### Work mode instructions

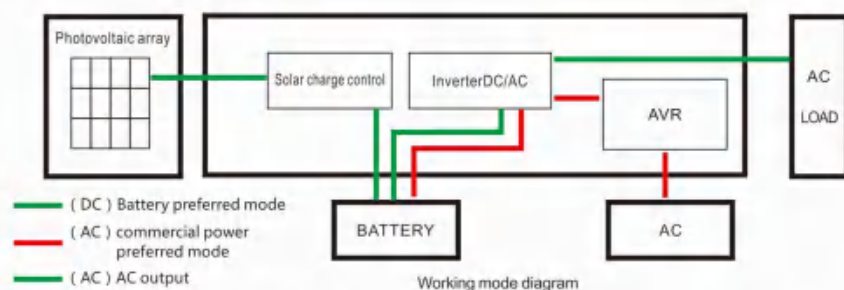

#### ( 1 ) ( DC ) Battery preferred mode

Under (DC) battery preferred mode, the batteries supply power to load, as shown of green arrow in the above picture.

- not only the power produced by solar panels will supply to user's appliances, but also the redundant power will be restored in the batteries
- When power produced by solar panels is not sufficient for user's load, the power restored in batteries will supplement to load.
- When batteries's power is not sufficient, power produced by solar panels is not sufficient, the system will switch over to AC to supply power to load. If batteries' power is gravely insufficient, the system will switch over to AC to supply power to load, besides, it will automatically start up AC to charge for batteries. When batteries are full charged to 100%, the system will return to (DC) battery work mode automatically.

#### ( 2 ) ( AC ) commercial power preferred mode

Under (AC) commercial power preferred mode, commercial power supply power to load, it is output to load through system AVR and isolating part, to make sure the stability of output power source.

- AC input supply power for user's load, at this time, power produced by solar panels only charge for batteries.
- When batteries' power is gravely insufficient, except for supply power for users' load, AC will start up to auxiliary charge for batteries. But it won't fully charge to batteries.
- When AC is off or abnormal, the system will switch over to batteries to supply power for load.

#### ( 3 ) Power saving mode

Under power saving mode, users can set the charging mode to PV charge preferred mode, at this time, AC will not charge to batteries.

#### ( 4 ) Off-peak power consumption mode

For countries and regions where electric accounted according to time-of use, users can set timing work mode switching according to requirements. Regarding off-peak power consumption function, it will use AC power during the time of low power grid load and cheap power rate, it will fully charge to batteries at the same time. During the time of peak power grid load, it will make use of power stored in batteries to realize the purpose of off-peak power consumption and save electricity cost.

## 7 Installation steps

- Prepare corresponding installation tools and measuring tools before installation and debugging Such as Philips screwdriver, diagonal pliers, multimeter, No.10 hammer wrench, etc.
- Check whether the required accessories are complete. Wire and switch shall be selected according to the selection table.
- Make sure all power switches of the machine are turned off. Confirm positive and negative poles of the battery, and its voltage is consistent with the input voltage of the machine.
- Select a black wire with appropriate cross-sectional area and connect them in sequence: battery negative --- negative terminal of the machine battery to complete the negative connection of the battery. Select a red wire with appropriate cross-sectional area. Battery positive--switch--positive terminal of the machine battery to complete the positive connection of the battery.
- Select wires with appropriate cross-sectional area and connect them in sequence: (AC live wire--switch--live wire terminal/ AC neutral-- neutral terminal/ AC earth wire--earth wire terminal). Completing AC input wiring.
- Repeat step 5 to complete AC output wiring.
- After checking each connection is correct, first of all, turn on battery switch. Second, press ON button of the display screen, then LCD screen will display normally.
- When the mains input switch is turned on, it can charge the battery and supply power to the load. The screen will display AC charging voltage and status.
- Turn on the mains output switch and the load can be used. It will display AC charging voltage and status.

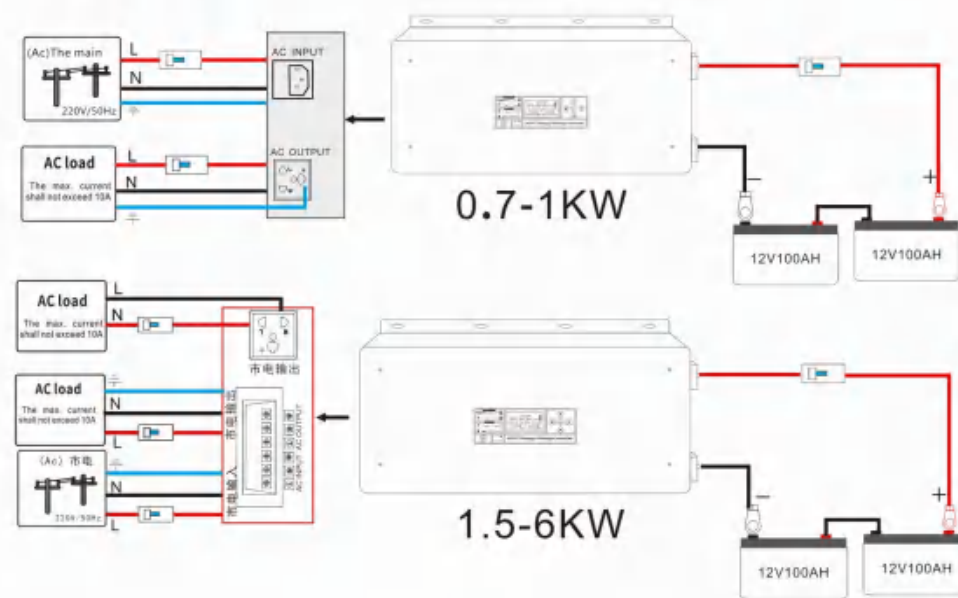

## 7 Trouble shooting and solutions

Trouble shooting and solutions		
Abnormal phenomena		solution
inverter	Overheated	1. Pls check whether the inverter is placed next to the heat source. Whether the fan port of the inverter has a shelter and the fan is working.
	Overload	1. Reduce load
	Battery overdischarge	1. The battery capacity is small and pls reduce load. 2. Battery aging. Pls repalce battery. 3. Weather. Extended charging time
	Output short circuit	1. Checking circuit.If it is due to overload, pls reduce the electrical load and restart the machine.
	Mains is not charged	1. Check for mains input. 2. Pls select AC prority option for working mode in the menu and choose PV+AC for charging mode.
	No AC output	1.The system is in standby mode, pls restart. 2.The system is in alarm protection state, pls release the alarm.

## 9 Quality guarantee

If the product fails during the quality assurance period, our company will provide free maintenance services or replace new products.

### Evidence

During quality guarantee, our company requires customer shows purchase invoice and date of the products. At the same time, logo on the products should be clear and distinct, or we have the right not to provide quality guarantee.

### Conditions

- Substandard products after replacement should be handled by our company.
- Customer should leave reasonable maintenance time to repair the failure equipment.

### Responsibility immunities

Our company have the right not to provide quality guarantee on the conditions below:

- The whole machine or components have exceeded free guarantee period.
- Transportation damage
- Incorrect installation, modification or use.
- Operated beyond very harsh environment illustrated in this manual.
- Machine failure or damage caused by maintain, change or disassemble by non-our company services.
- Damages caused by abnormal natural environment.

Products failure caused by situations above, if customer requires maintenance service, we can provide paid maintenance service after our company service institution judgments.

### Illustration

Any variation in product dimension and parameters will be subject to our company latest information, without prior notice.